

BASI E PENSILI

CARATTERISTICHE TECNICHE TECHNICAL FEATURES

SCOCCA

MELAMINICO: Truciolare Melaminico idrorepellente E1 sp. 22 mm 2 lati in finitura

LACCATO OPACO: Truciolare Melaminico Idrorepellente E1 sp. 22 mm 1 lato esterno in finitura

CARCASS

MELAMINE: Waterproof chipboard class E1 th.22 mm coated with melamine in the chosen finish, both inside and outside

LACQUERED MATT: Waterproof chipboard class E1 th.22 mm coated with melamine in the chosen finish outside

FRONTALI

MELAMINICO: Truciolare Melaminico idrorepellente E1 sp. 22 mm 2 lati in finitura

LACCATO OPACO: Truciolare Melaminico idrorepellente E1 sp. 22 mm 2 lati in finitura

FRONTI

MELAMINE: Waterproof chipboard class E1 th.22 mm coated with melamine in the chosen finish, both inside and outside

LACQUERED MATT: Waterproof chipboard class E1 th.22 mm coated with melamine in the chosen finish, both inside and outside

CASSETTI

Cassetto in truciolare melaminico in finitura Biscotto

DRAWERS

Drawer made of chipboard, coated with melamine in Biscotto finish

FINITURE FINISHES

Melaminico – Colour Melamine – Colour

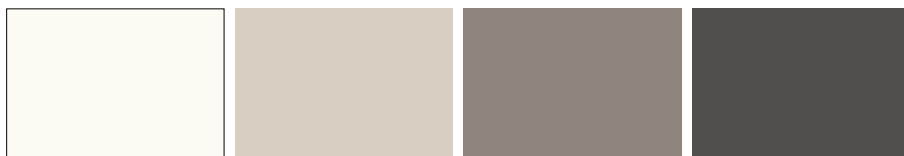

Fiocco

Biscotto

Camoscio

Ardesia

Melaminico – Wood Melamine – Wood



Olmo Snow

Rovere White

Rovere Chiostro

Noce Bohème

Laccato opaco Matt lacquered

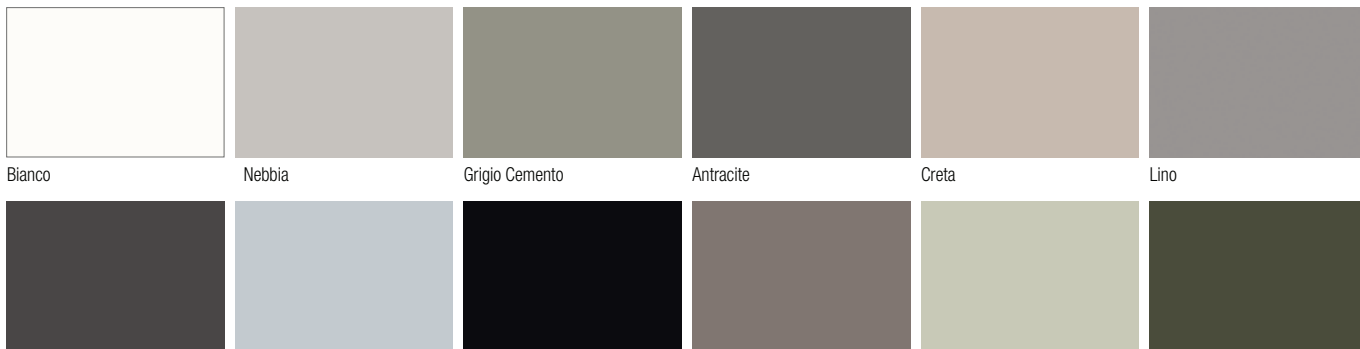

Bianco

Nebbia

Grigio Cemento

Antracite

Creta

Lino

Piombo

Ghiaccio

Blu Notte

Tortora

Quarzo

Roccia

MANIGLIE HANDLES

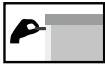

LINE LINE



In alluminio L. 12,5 cm P. 1,8 cm
Finiture disponibili: Cromo
Made of aluminium W. 12.5 cm D. 1.8 cm
Available finishes : Chrome

STILO STILO



In alluminio L. 21 cm P. 2,9 cm
Finiture disponibili: Nero - Nichel
Made of aluminium W. 21 cm D. 2,9 cm
Available finishes : Black - Nickel

TYRE TYRE



In alluminio Ø 1,2 cm P. 2,2 cm
Finiture disponibili: Nero - Acciaio Spazzolato
Made of aluminium Ø 1,2 cm D. 2,2 cm
Available finishes : Black – Brushed Steel



GOLA GROOVE



In alluminio
Finiture disponibili: Cromo - Nichel
Made of aluminium
Available finishes : Black – Nickel

CARATTERISTICHE TECNICHE GENERALI – CASSETTI GENERAL TECHNICAL FEATURES – DRAWERS

L= Larghezza modulo
B= Int. Cassetto
L= Cabinet width
B= Drawer width

Scocca cassetto in melaminico finitura Biscotto.
Guide metalliche ad estrazione parziale con sistema di chiusura "Soft Close" integrato.

Melamine drawer structure in finish Biscotto.
Partially extractable metal guides with integrated "Soft Close" closing system.

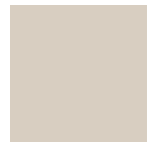

Biscotto

Basi dritte Linear base cabinets

H. 50

H. 90.5

L	B
30	20.8
40	30.8
50	40.8
60	50.8
70	60.8
80	70.8
100	90.8
120	110.8

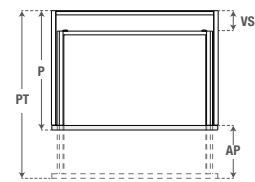
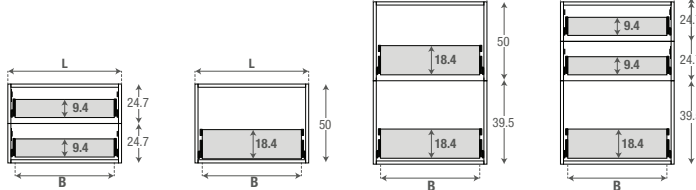

P	AP	PT	VS	SF
50	31	81	15	40
65	51	116	10	35
70	51	121	15	40

Basi lavabo dritte Linear Washbasin base cabinets

H. 50

H. 90.5

L	B
60	50.8
70	60.8
80	70.8
100	90.8
120	110.8

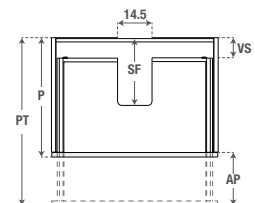
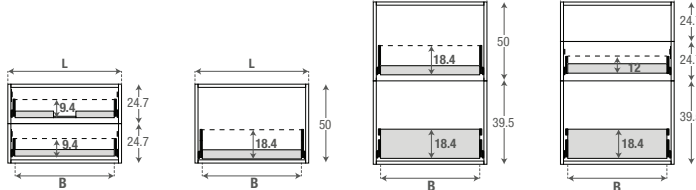

P	AP	PT	VS	SF
50	31	81	15	40
65	51	116	10	35
70	51	121	15	40

ARMADI ED ELEMENTI SPALLA

CARATTERISTICHE TECNICHE TECHNICAL FEATURES

SCOCCHA	MELAMINICO:	Truciolare Melaminico idrorepellente E1 sp. 22 mm 2 lati in finitura	MELAMINE:	Waterproof chipboard class E1 th.22 mm coated with melamine in the chosen finish, both inside and outside
	LACCATO OPACO:	Truciolare Melaminico Idrorepellente E1 sp. 22 mm 1 lato esterno in finitura	LACQUERED MATT:	Waterproof chipboard class E1 th.22 mm coated with melamine in the chosen finish, both inside and outside
FRONTALI	MELAMINICO:	Truciolare Melaminico idrorepellente E1 sp. 22 mm 2 lati in finitura	MELAMINE:	Waterproof chipboard class E1 th.22 mm coated with melamine in the chosen finish, both inside and outside
	LACCATO OPACO:	Truciolare Melaminico idrorepellente E1 sp. 22 mm 2 lati in finitura	LACQUERED MATT:	Waterproof chipboard class E1 th.22 mm coated with melamine in the chosen finish, both inside and outside

FINITURE FINISHES

Melaminico – Colour Melamine – Colour



Fiocco

Biscotto

Camoscio

Ardesia

Melaminico – Interno Melamine – For the inside



Tessuto bianco

Melaminico – Wood Melamine – Wood



Olmo Snow

Rovere White

Rovere Chiostro

Noce Bohème

Laccato opaco Matt lacquered



Bianco

Nebbia

Grigio Cemento

Antracite

Creta

Lino



Piombo

Ghiaccio

Blu Notte

Tortora

Quarzo

Roccia

MANIGLIE HANDLES

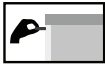

LINE LINE



In alluminio L. 12,5 cm P. 1,8 cm
Finiture disponibili: Cromo
Made of aluminium W. 12.5 cm D. 1.8 cm
Available finishes : Chrome

STILO STILO



In alluminio L. 21 cm P. 2,9 cm
Finiture disponibili: Nero - Nichel
Made of aluminium W. 21 cm D. 2,9 cm
Available finishes : Black - Nickel

TYRE TYRE



In alluminio Ø 1,2 cm P. 2,2 cm
Finiture disponibili: Nero - Acciaio Spazzolato
Made of aluminium Ø 1,2 cm D. 2,2 cm
Available finishes : Black – Brushed Steel

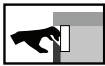

GOLA GROOVE



SMALL



LARGE

In alluminio
Finiture disponibili: Cromo - Nichel
Made of aluminium
Available finishes : Black – Nickel

Disponibile solo su ante battenti a terra

Available only for hinged doors that do not have an open niche under them

TIPI DI APERTURA DOORS: OPENING TYPES

Battente Hinged door

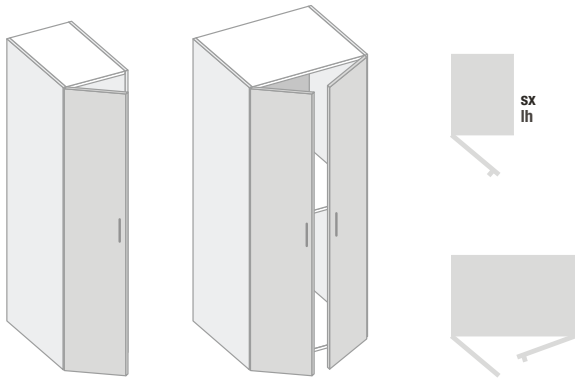

Una maniglia di serie
Standard Supplied
w/1 handle

LINE/STILO/TYRE: 2 maniglie di serie
GOLA: 1 maniglia di serie
LINE/STILO/TYRE: 2 standard handles GOLA:
1 standard handle

Magg. per 2^ Maniglia – CAD.
Price increase for second handle – each.

GOLA SMALL
GROOVE SMALL
GOLA LARGE
GROOVE LARGE

AX3020	82
AX3025	82

Magg. per cerniere 165°
Price increase for 165° hinges

AX3500	50
--------	----

Libro Folding door

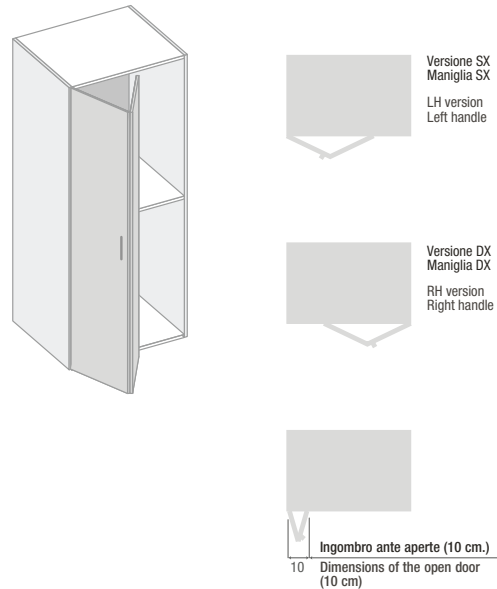

Versione SX
Maniglia SX
LH version
Left handle

Versione DX
Maniglia DX
RH version
Right handle

Ingombro ante aperte (10 cm.)
10 Dimensions of the open door
(10 cm)

MODULARITÀ MODULARITY

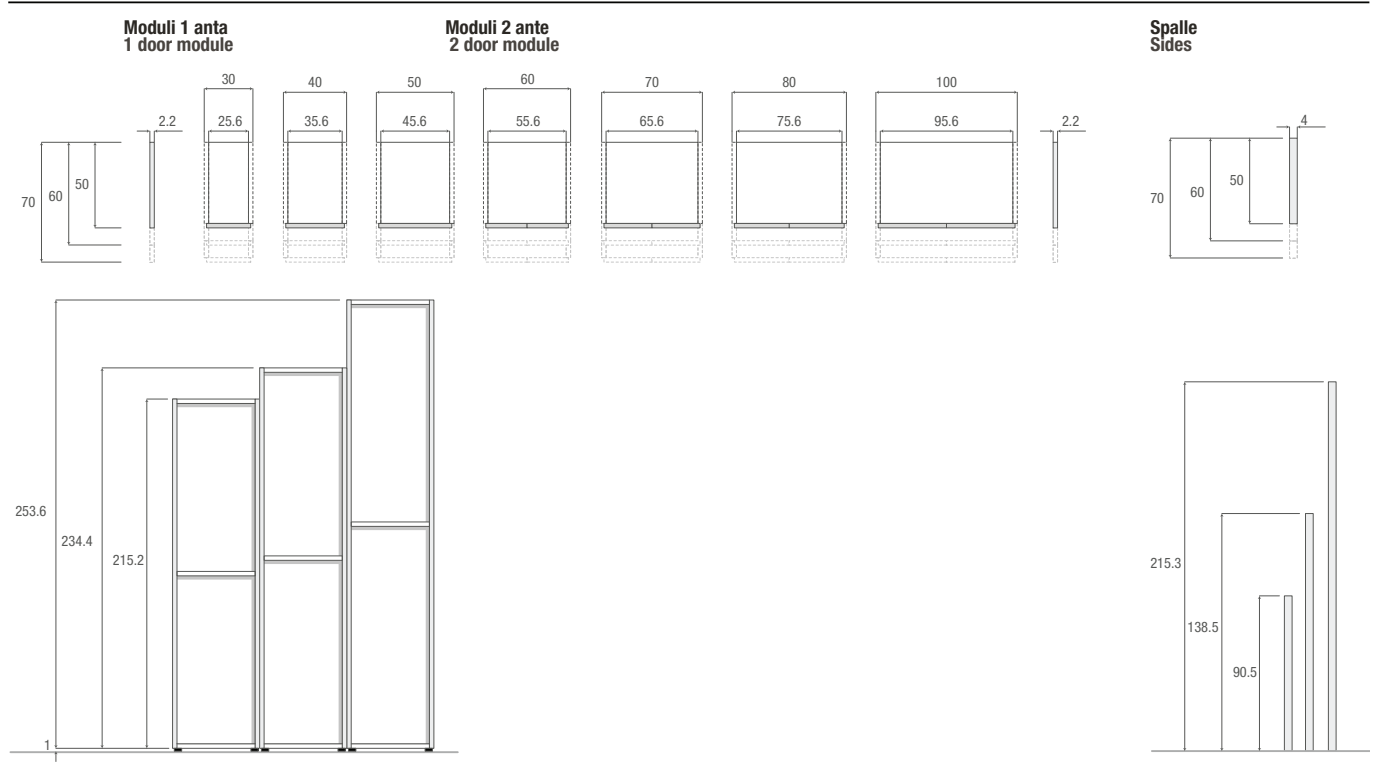

REGOLE DI COMPONIBILITÀ MODULARITY RULES

Soluzioni ad angolo Corner solutions

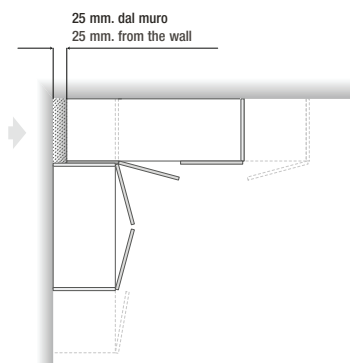

Nelle soluzioni con modulo ad angolo considerare sempre una distanza dal muro di 25 mm.
In solutions with corner module always consider a distance from the wall of 25 mm.

Modulo armadio senza schiena per moduli in nicchia Backless wardrobe module

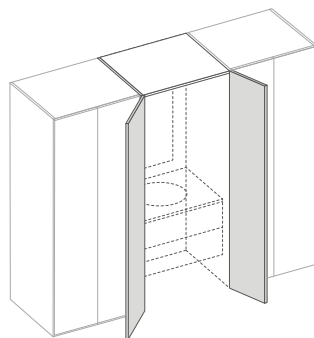

Il modulo armadio senza schiena non può mai essere usato da solo ma compreso tra due moduli.
The backless wardrobe module cannot be used alone but only between two modules.

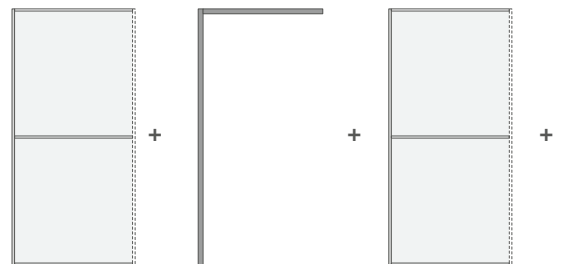

Sempre compreso tra due moduli.
Always between two modules.

ESEMPIO DI CALCOLO PREZZO COMPOSIZIONI EXAMPLE OF CONFIGURATION OF VARIOUS UNITS

Esempio composizione armadio L 205.6 H 234.5 P 65 Example of wardrobe composition W 205.6 H 234.5 D 65

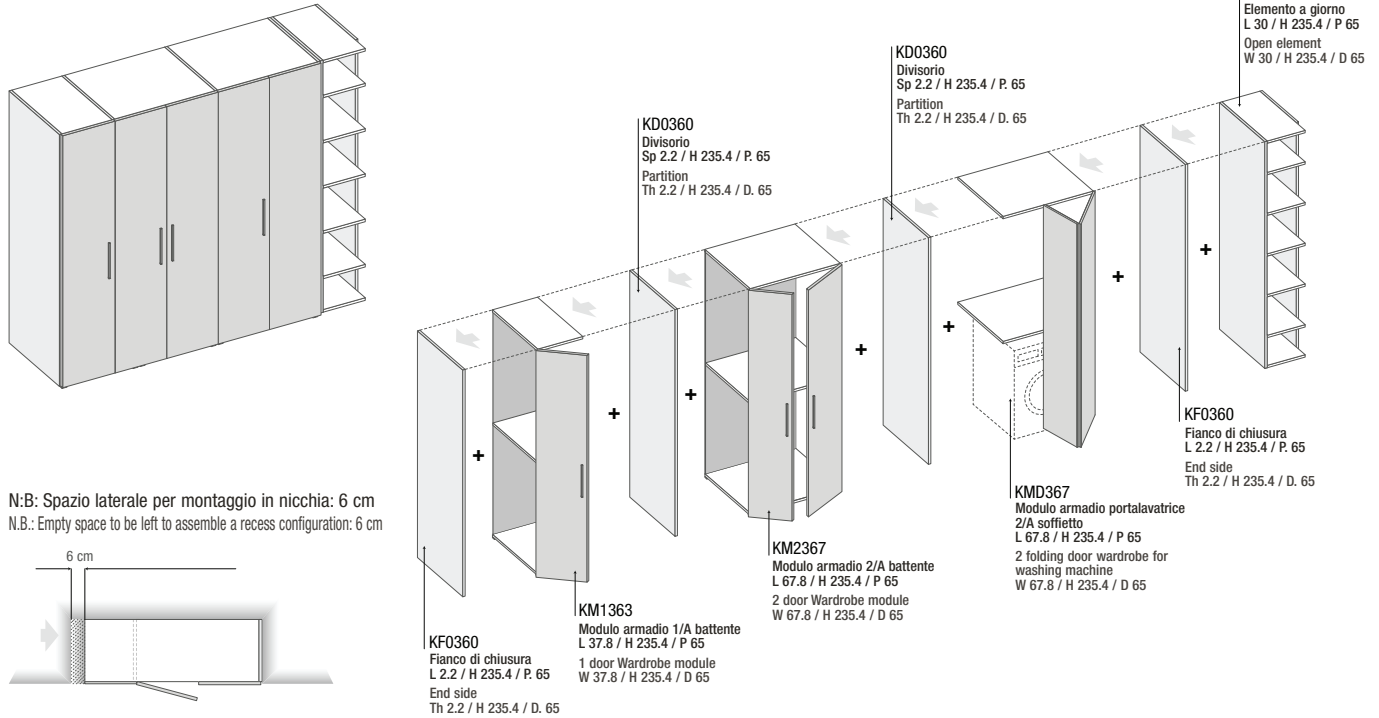

Esempio composizione spalla L 242.4 H 216.3 P 50 Example of composition with open elements W 242.4 H 216.3 D 50

